

Unter Haßlen 20 · D-78532 Tuttlingen
Phone: +49 (0)7462/9470-0
Fax: +49 (0)7462/9470-50
e-mail: sales@rz-medizintechnik.com
<http://www.rz-medizintechnik.com>

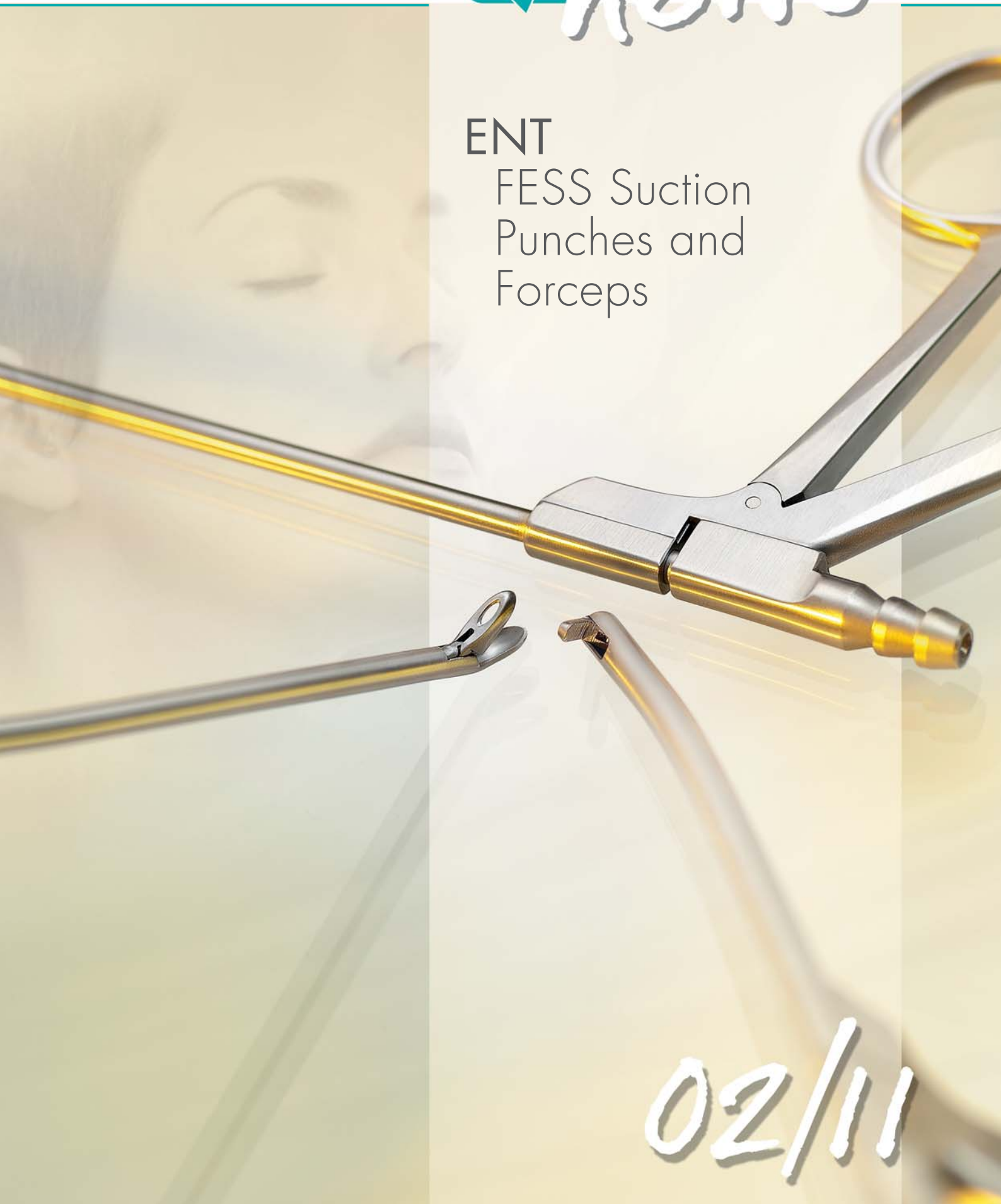

ENT
FESS Suction
Punches and
Forceps



02/11

ENT FESS SUCTION PUNCHES AND FORCEPS

For many years RZ Medizintechnik GmbH offers a wide range of special ENT instruments. Today RZ Medizintechnik GmbH presents the latest products in ENT surgery - FESS Suction Punches and Suction Forceps.

RZ FESS Suction Punches and Suction Forceps feature an integrated suction channel with 3 major benefits for the surgeons:

1. Tissue will be retracted inside the jaws for safe and precise cutting.
2. Tissue parts will be automatically aspirated for continuous working without instrument removal.
3. Blood and other fluids can be easily aspirated for a clear view during surgery.



ADULT SIZE

- | 252-015-500
Ostrom Suction Punch, straight, upside backward cutting,
100mm working length, \varnothing 5mm, 2.5mm bite
- | 252-015-510
Left side backward cutting
- | 252-015-520
Right side backward cutting
- | 252-015-600
Upturned shaft, upside backward cutting

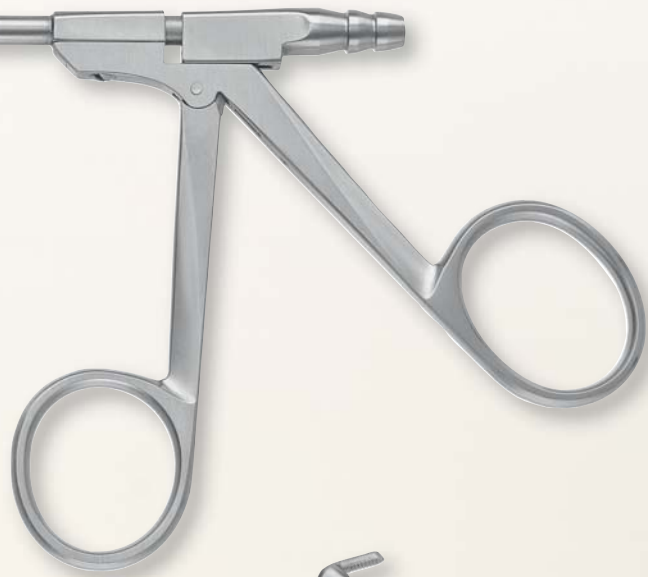

Backward cutting



Integrated suction channel



Upturned shaft

PEDIATRIC SIZE

- | 252-015-300
Ostrom Suction Punch, straight, upside backward cutting,
100mm working length, \varnothing 4mm, 2.0mm bite
- | 252-015-310
Left side backward cutting
- | 252-015-320
Right side backward cutting
- | 252-015-400
Upturned shaft, upside backward cutting

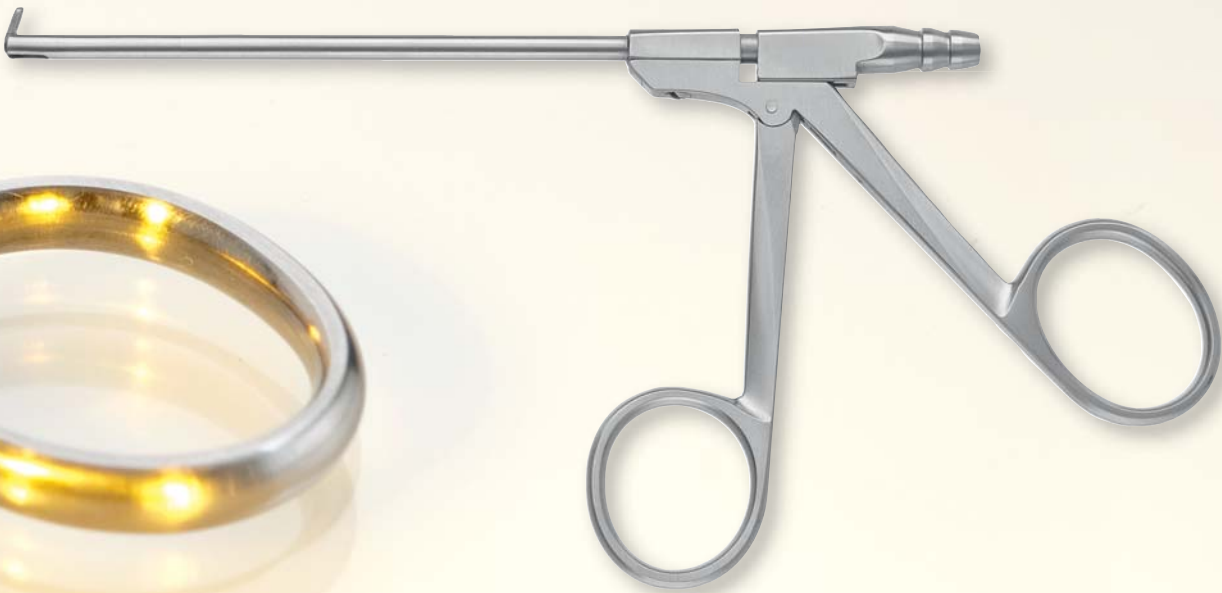



| 252-502-100

Thru-cutting Biopsy Forceps with suction, 2mm bite,
straight, 100mm working length



Thru-cutting



Integrated
suction channel

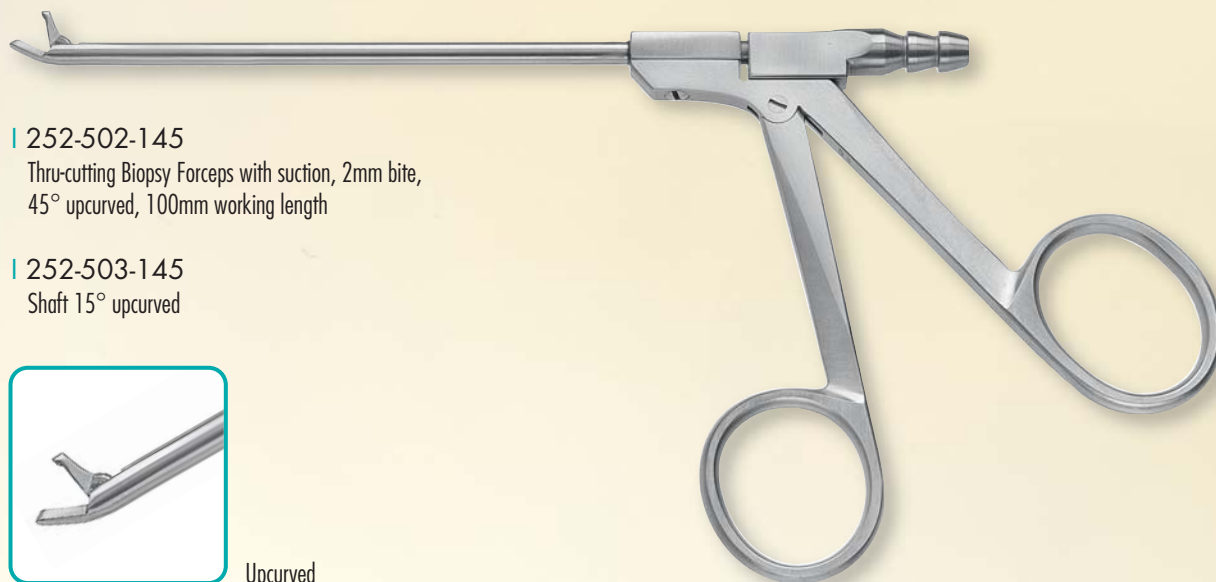

| 252-502-145

Thru-cutting Biopsy Forceps with suction, 2mm bite,
45° upcurved, 100mm working length

| 252-503-145

Shaft 15° upcurved



Upcurved

| 252-504-100

Thru-cutting Biopsy Suction Punch, frontal suction channel,
detachable, 100mm working length, 2.5mm bite



Frontal
suction channel



Detachable

| 252-505-100

Thru-cutting Biopsy Suction Punch, frontal suction channel,
45° upcurved, detachable, 100mm working length, 2.5mm bite

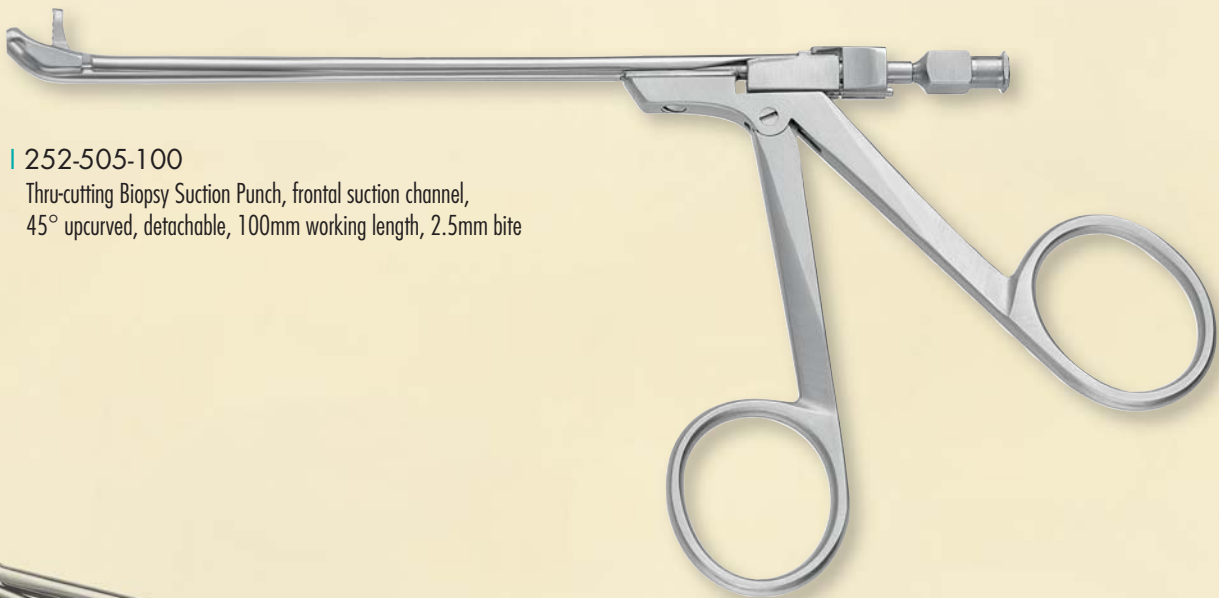

Detachable for easy
and efficient cleaning



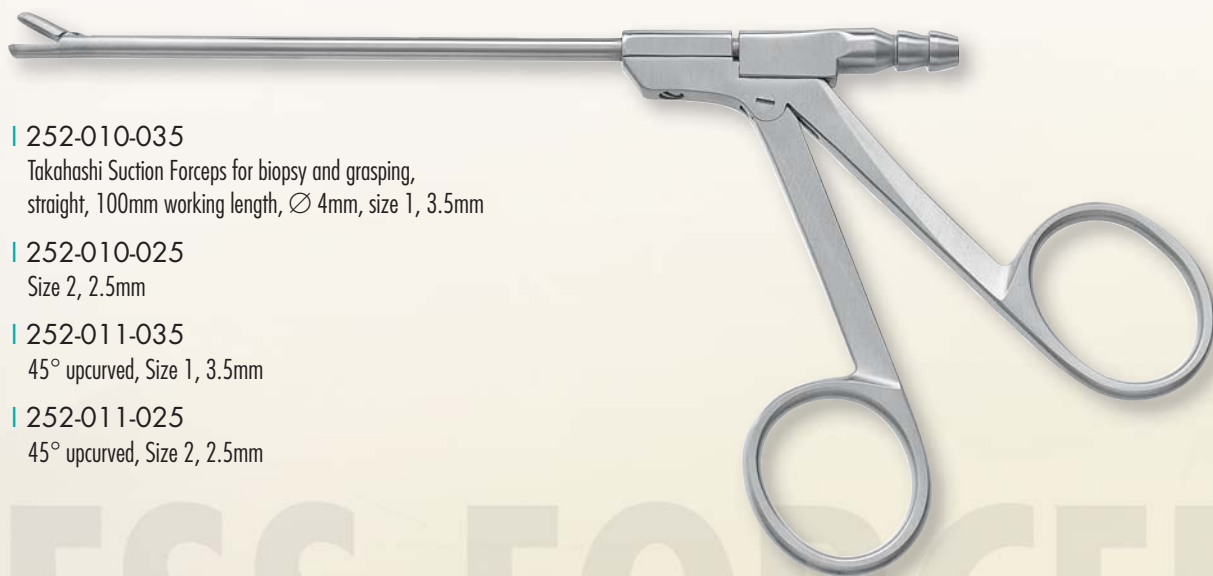

| 252-010-035

Takahashi Suction Forceps for biopsy and grasping,
straight, 100mm working length, \varnothing 4mm, size 1, 3.5mm

| 252-010-025

Size 2, 2.5mm

| 252-011-035

45° upcurved, Size 1, 3.5mm

| 252-011-025

45° upcurved, Size 2, 2.5mm

FORCEPS



Takahashi
jaw



Integrated
suction channel





- | 252-021-100
Blakesley Suction Forceps, straight,
100mm working length, Ø 4mm, size 1, 2.5mm
- | 252-022-100
Size 2, 3.5mm
- | 252-023-100
Size 3, 4.0mm



Blakesley
jaw



Integrated
suction channel

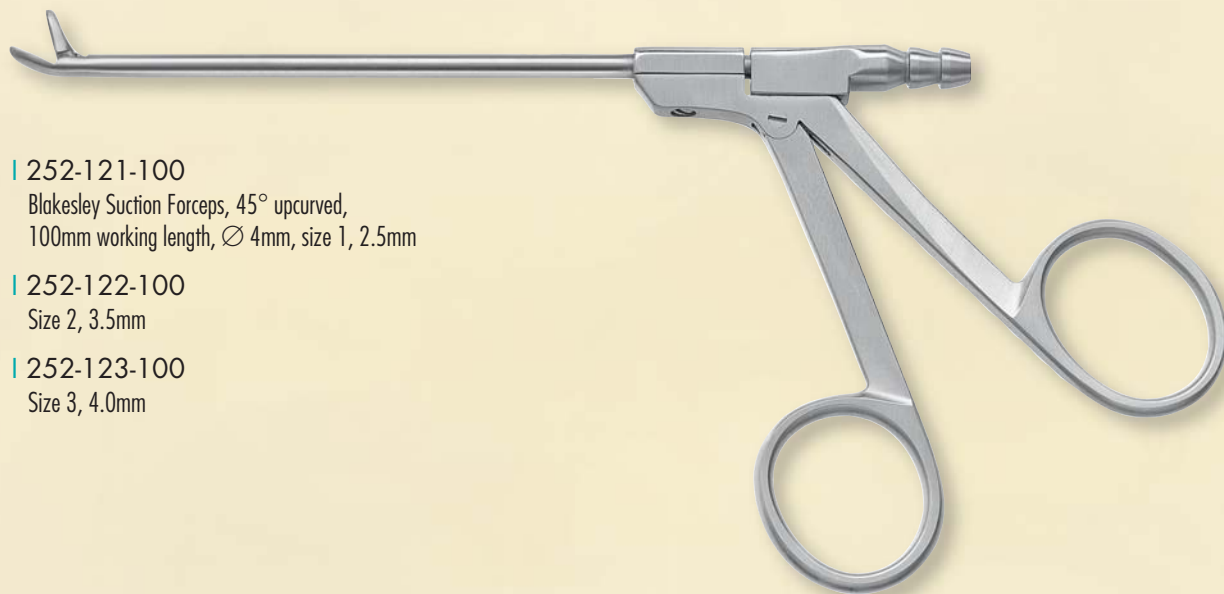

- | 252-121-100
Blakesley Suction Forceps, 45° upcurved,
100mm working length, Ø 4mm, size 1, 2.5mm
- | 252-122-100
Size 2, 3.5mm
- | 252-123-100
Size 3, 4.0mm



More Sinuscopy Instruments are shown in our comprehensive ENT Catalogue.