

OPEN SURGERY

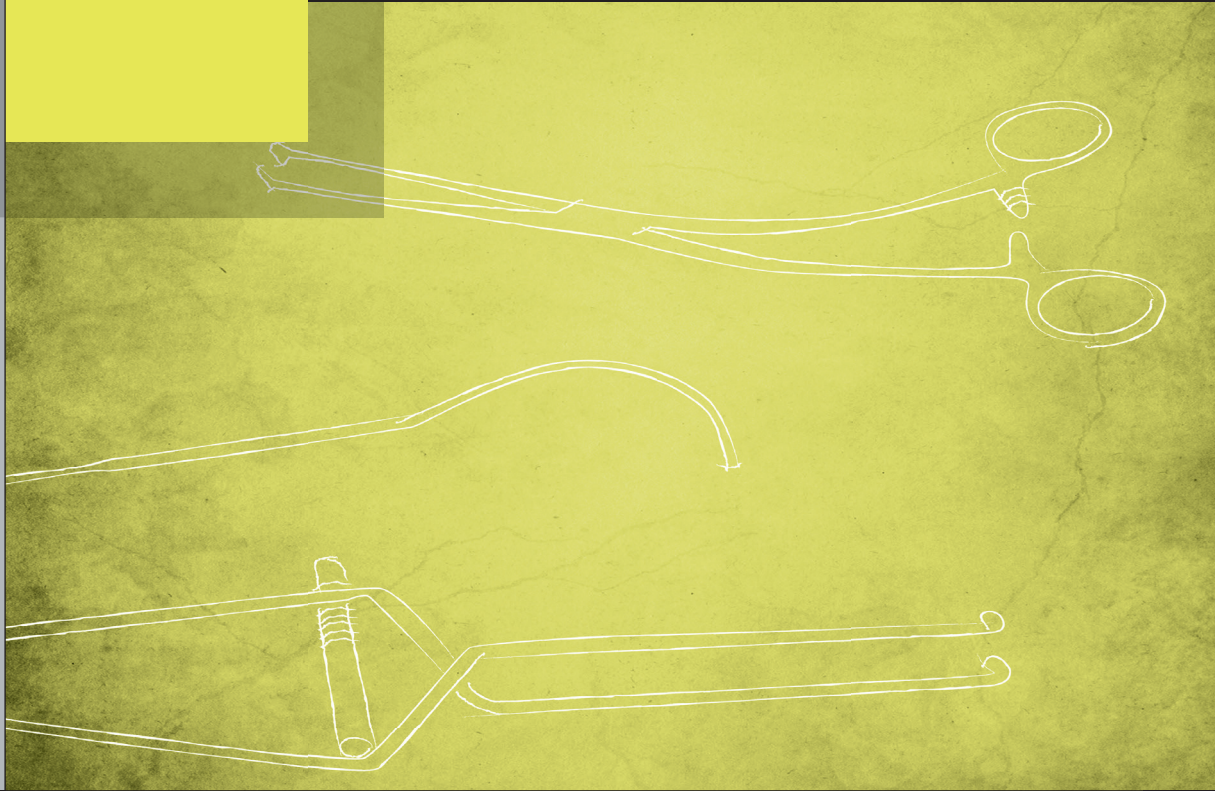

Urologie

Urology

Urologia

Urologie

Urologia

170



Art.Nr.	Beschreibung Description	Size	Spez.
---------	----------------------------	------	-------

URO-TANGENTIAL

24,0 cm; 9 1/2"

ATRAUMA

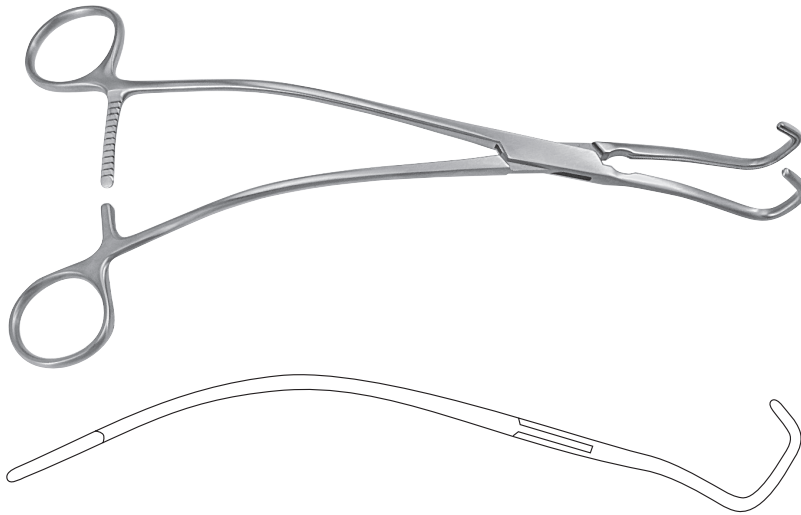

170-055-01

Fig. 1

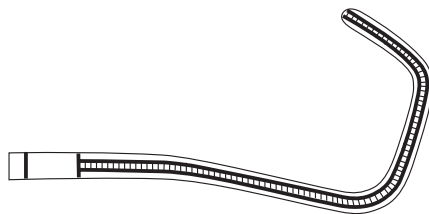

170-055-02

Fig. 2

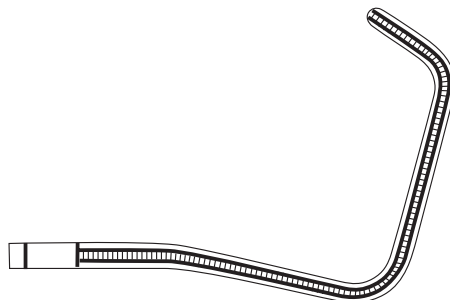



1/1

Kapselfasszange; Fadenführungszange
Capsule Forceps; Ligature Carrying Forceps

Pinzas capsulares; Pinzas porta ligaduras
 Pince pour saisir les capsules; Pince porte-fil
 Pinza per afferrare capsule; Pinza porta-filo

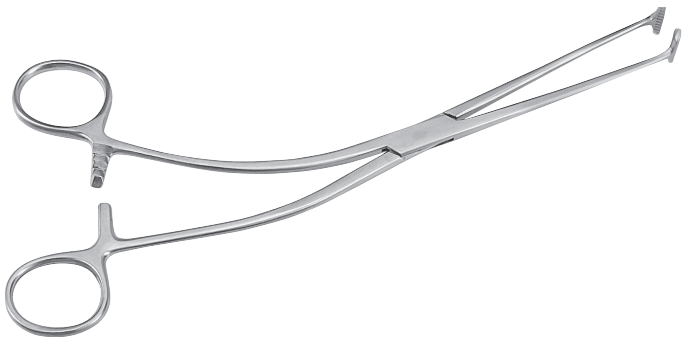
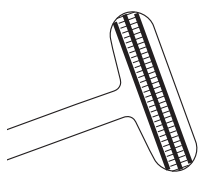
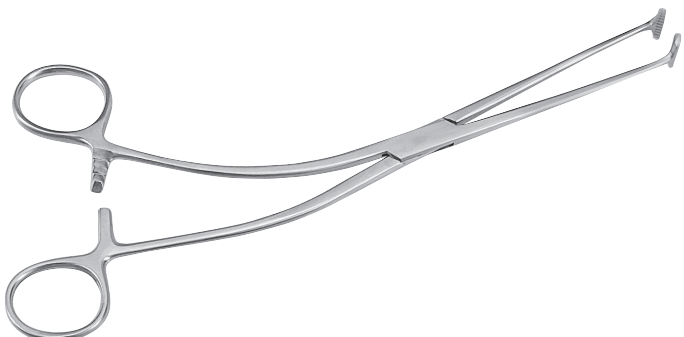
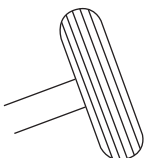
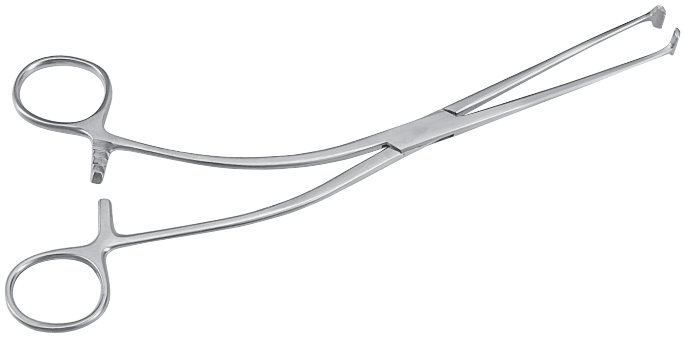

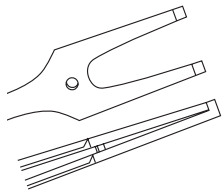
Art.Nr.	Beschreibung Description	Size	Spez.
170-071-24	<p>MILLIN</p>  	24,5 cm; 9 5/8"	<p>ATRAUMA</p>
1/1			
170-073-23	<p>MILLIN</p>  	24,5 cm; 9 5/8"	
1/1			
170-075-23	<p>MILLIN</p>  	22,0 cm; 8 5/8"	9 x 10
1/1			
170-077-24	<p>MILLIN</p>  	24,0 cm; 9 4/8"	
1/1			

Fremdkörperzangen; Urethrotom
Foreign Body Forceps; Urethrotome

Pinza para cuerpos extraños; Uretrótomo
 Pince pour les corps étrangers; Urétrótome
 Pinza per corpi estranei; Uretrotomi



Art.Nr.	Beschreibung Description	Size	Spez.
---------	----------------------------	------	-------

MATHIEU

170-080-20 20,0 cm; 7 7/8"

170-080-28 28,0 cm; 11"

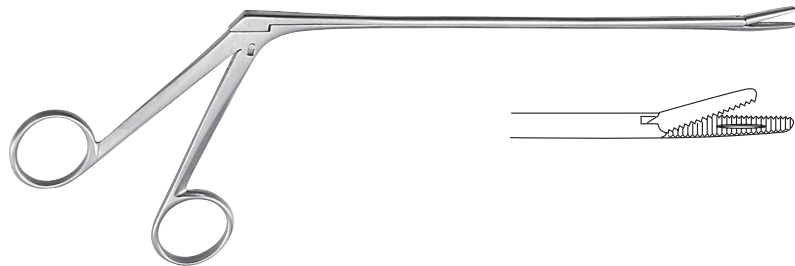

1/1

170-100-00 **OTIS** komplett im Holzetui, mit Dilatator, 2 Messern und 3 Ansätzen
 complete in wooden case, with dilator, 2 knives and 3 tips
 completo en caja de madera, con dilatador, 2 cuchillos y 3 puntas
 complet en boîte de bois, avec dilateur, 2 lames et 3 embouts
 completo in contenitore di legno, con dilatatore, 2 bisturi e 3 punte

SET



170-100-10 **Ersatzmesser allein**
Spare blade only
 Cuchillo de repuesto
 Couteau de rechange
 Lama di ricambio



170

Blasenwundspreizer
Bladder Retractors

Separadores vesicales
Ecarteurs vésicaux
Divaricatore vescicale



Art.Nr.	Beschreibung Description	Size	Spez.
170-150-28	MILLIN	29,5 cm; 11 5/8"	

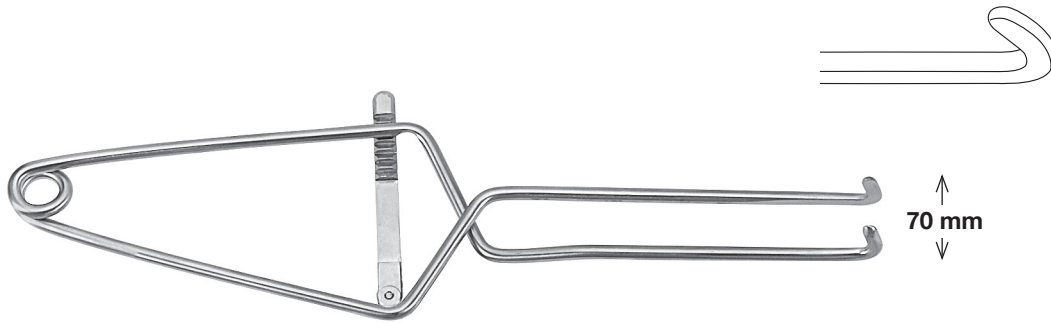

170-172-00	JUDD-MASSON
------------	-------------

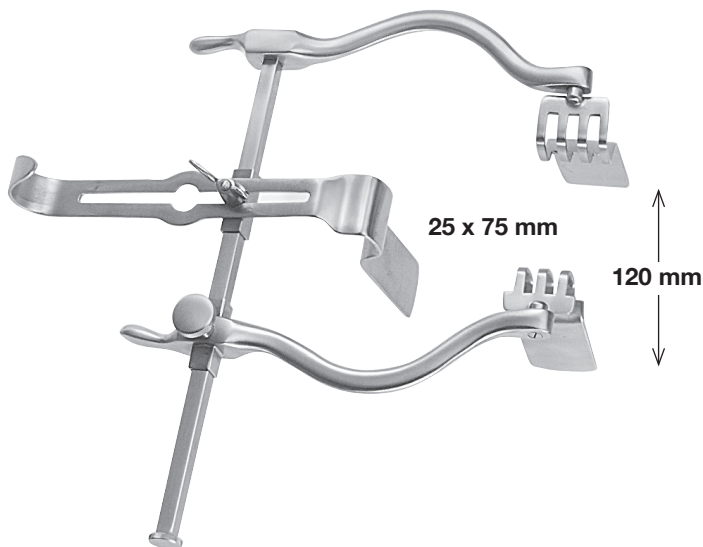



Art.Nr.	Beschreibung Description	Size	Spez.
---------	----------------------------	------	-------

170-176-00	MILLIN mit Seitenvalven; mit Mittelvalve with lateral valves; with centerblade con valvas laterales y valva central avec valves laterales; valve centrale con valva laterale; valva centrale		SET
------------	--	--	-----

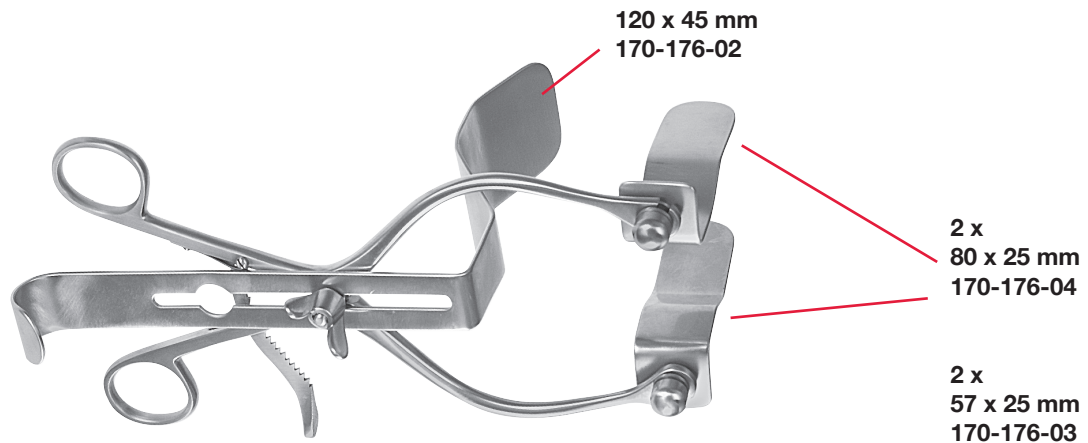

170-176-02	Mittelvalve allein Central valves only Valva central Valve centrale Valva centrale	120 x 45 mm
------------	--	-------------

170-176-03	Seitenvalven; Paar Lateral valves; pair Valvas laterales; par Valve laterale; paire Valva laterale; paio	57 x 25 mm
------------	--	------------

170-176-04	Seitenvalven; Paar Lateral valves; pair Valvas laterales; par Valve laterale; paire Valva laterale; paio	80 x 25 mm
------------	--	------------

170-176-01	Sperrer allein Retractor only Separador suelto Ecarteur seul Divaricatore solo	
------------	--	--

170

Prostatahaken
Prostatic Retractors

Separadores para próstata
Ecarteurs prostatiques
Divaricatori prostatici



Art.Nr.	Beschreibung Description	Size	Spez.
170-230-21	YOUNG	21,5 cm; 8 4/8"	



170-236-22	YOUNG	22,0 cm; 8 5/8"	
------------	-------	-----------------	--

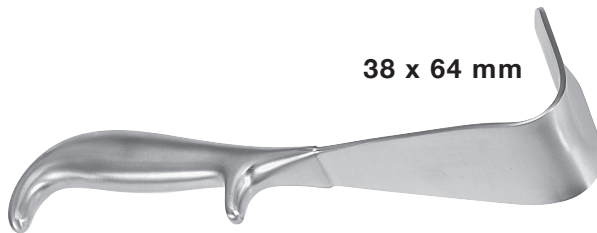

170-238-21	YOUNG	21,5 cm; 8 4/8"	
------------	-------	-----------------	--



170-240-22	YOUNG	23,0 cm; 9"	
------------	-------	-------------	--



Blasenspatel; Penisklemmen
Bladder spatula; Penis Clamps

Espátulas vesicales; Clamps para pene
Spatule vésicale; Pincés pour pénis
Spatola vescicale; Serrapene



Art.Nr.	Beschreibung Description	Size	Spez.
170-250-26	LEGUEU	27,0 cm; 10 5/8" 35 mm	



170-257-23	KOCHER	26,0 cm; 10 2/8" 67 mm	
------------	---------------	---------------------------	--



170-345-08	STOCKMANN	8,0 cm; 3 1/8"	
------------	------------------	----------------	--

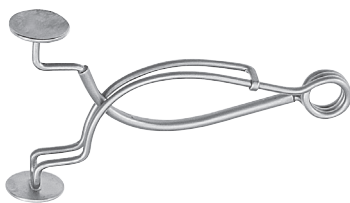

170-349-11	STRAUSS	11,0 cm; 4 3/8"	
------------	----------------	-----------------	--



170

Circumensionsgerät
Circumcision Instrument

Instrumento para circuncisión

Instrument de circoncision

Strumento per circoncisione



Art.Nr.	Beschreibung Description	Size	Spez.
COMCO			
			
170-350-08	Ø 8,0 mm	für Säuglinge for infants para lactantes pour bébé per neonati	
170-350-11	Ø 11,0 mm	für Knaben for boys para niños pour garçon per bambini	
170-350-13	Ø 13,0 mm	für Knaben for boys para niños pour garçon per bambini	
170-350-16	Ø 16,0 mm	für Jugendliche for teenager para adolescentes pour adolescent per adolescente	
170-350-21	Ø 21,0 mm	für Jugendliche for teenager para adolescentes pour adolescent per adolescente	
170-350-26	Ø 26,0 mm	für Männer for men para hombres pour homme per adulti	
170-350-32	Ø 32,0 mm	für Männer for men para hombres pour homme per adulti	



Art.Nr.	Beschreibung Description	Size	Spez.
---------	----------------------------	------	-------

GUYON

26,5 cm; 10 3/8"



170-610-10	Charr. 10	170-610-17	Charr. 17	170-610-24	Charr. 24
170-610-11	Charr. 11	170-610-18	Charr. 18	170-610-25	Charr. 25
170-610-12	Charr. 12	170-610-19	Charr. 19	170-610-26	Charr. 26
170-610-13	Charr. 13	170-610-20	Charr. 20	170-610-27	Charr. 27
170-610-14	Charr. 14	170-610-21	Charr. 21	170-610-28	Charr. 28
170-610-15	Charr. 15	170-610-22	Charr. 22	170-610-29	Charr. 29
170-610-16	Charr. 16	170-610-23	Charr. 23	170-610-30	Charr. 30

170-610-00 Set mit 21 Bougies und 4 Gleitsonden im Metalletui
 Set with 21 sounds and 4 filiform bougies in metal case
 Set con 21 bujías y 4 sondas filiformes en caja metálica
 Kit avec 21 bougies et 4 bougies filiformes en boîte métal
 Set con 21 candelette e 4 candeletti filiforme in contenitore metallico

VAN BUREN

27,0 cm; 10 5/8"

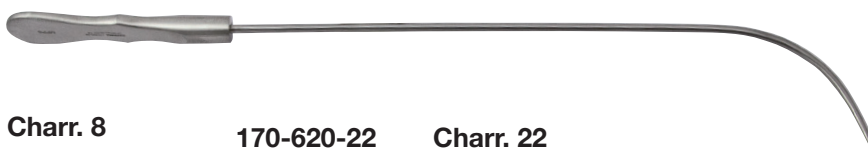

170-620-08	Charr. 8	170-620-22	Charr. 22
170-620-10	Charr. 10	170-620-24	Charr. 24
170-620-12	Charr. 12	170-620-26	Charr. 26
170-620-14	Charr. 14	170-620-28	Charr. 28
170-620-16	Charr. 16	170-620-30	Charr. 30
170-620-18	Charr. 18	170-620-32	Charr. 32
170-620-20	Charr. 20	170-620-34	Charr. 34
		170-620-36	Charr. 36

170-620-99 Set mit 15 Bougies; 8 Charr.- 36 Charr.
 Set with 15 sounds; 8 Charr.- 36 Charr.
 Set con 15 bujías; 8 Charr.- 36 Charr.
 Kit avec 15 bougies; 8 Charr.- 36 Charr.
 Set con 15 candelette; 8 Charr.- 36 Charr.